

Stainless Steel Bubblers, vertical, electropolished with fill-port, PCTFE valve stem tip (121°C)								
Catalog #	Vol. (mL)	A mm	B mm	C mm	D mm	E mm	Temp. Valve	Special Configuration
96-4151	150	51	108	140	83	13	Standard	
96-4290	300	51	187	140	83	13	Standard	
96-4598	600	76	163	140	83	13	Standard	
96-4998	1000	76	254	140	83	13	Standard	
96-5002	1000	102	165	140	83	13	Standard	
96-5003	1400	102	203	140	83	13	Standard	
96-5001	1800	102	254	140	83	13	Standard	
96-5011	2750	152	188	140	83	13	Standard	
96-4149	150	51	108	140	83	13	Standard	with short dip tube, cut to 5cm from top of bubbler
96-4153	150	51	108	140	83	13	Standard	with rotated handles

Stainless Steel Bubblers, vertical, electropolished with fill-port, high temperature valves (315°C)								
Catalog #	Vol. (mL)	A mm	B mm	C mm	D mm	E mm	Temp. Valve	Special Configuration
98-0271	150	51	108	140	83	13	High	
98-0270	300	51	187	140	83	13	High	
96-4599	600	76	163	140	83	13	High	
96-4996	1000	76	254	140	83	13	High	
98-0276	150	51	108	140	83	13	High	with short dip tube, cut to 1 inch from top of bubbler
98-0280	300	51	187	140	83	13	High	with rotated handles
96-4295	300	51	187	140	83	13	High	with rotated handles, no dip tube
96-4610	600	76	163	140	83	13	High	with rotated handles, no dip tube , stems same height

See reverse side for Horizontal Stainless Steel Bubblers

Visit www.strem.com for new product information and a searchable catalog.

Strem Chemicals, Inc.
7 Mulliken Way
Newburyport, MA 01950
U.S.A.
Tel: 978.499.1600
Fax: 978.465.3104
Email: info@strem.com

Strem Chemicals, Inc.
15, rue de l'Atome
Zone Industrielle
67800 BISCHHEIM France
Tel: (33) 03 88 62 52 60
Fax: (33) 03 88 62 26 81
Email: info.europe@strem.com

Strem Chemicals, Inc.
Postfach 1215
77672 KEHL
Germany
Tel: 0 78 51/ 7 58 79
Email: info.europe@strem.com

Strem Chemicals UK Ltd.
An Independent Distributor of Strem Chemicals Products
Newton Hall, Town Street
Newton, Cambridge
England CB22 7ZE
Tel: 0845 643 7263
Fax: 0845 643 7362
Email: enquiries@strem.co.uk

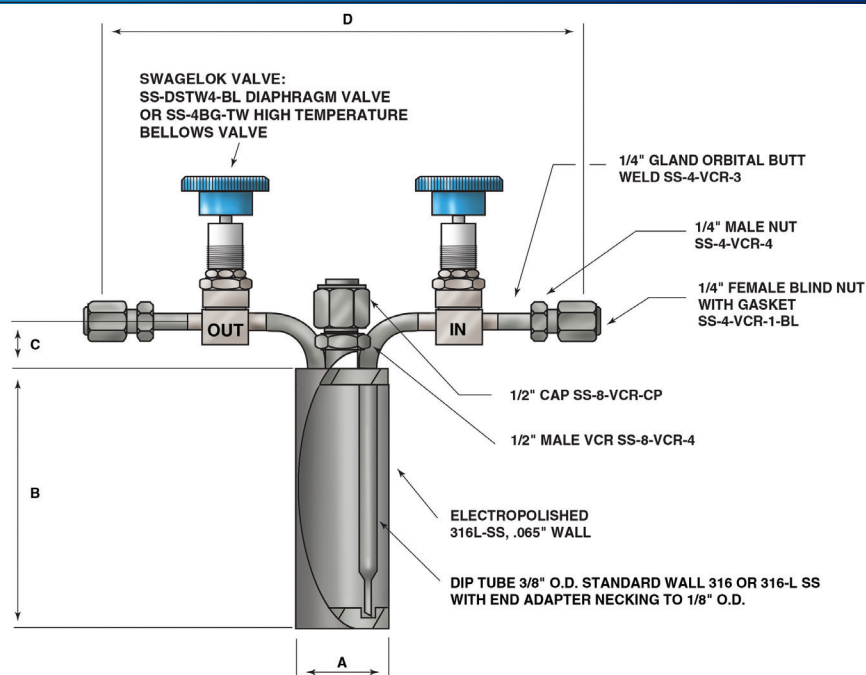

Stainless Steel Bubblers, horizontal, electropolished with fill-port, PCTFE valve stem tip (121°C)							
Catalog #	Vol. (mL)	A mm	B mm	C mm	D mm	Temp. Valve	Special Configuration
96-5151	150	51	108	24	222	Standard	
96-5298	300	51	187	24	222	Standard	
96-5599	600	76	163	24	222	Standard	
96-5998	1000	76	254	24	222	Standard	
96-5004	1800	102	254	24	222	Standard	
98-0273	150	51	108	24	222	Standard	with reversed handles
98-0275	150	51	108	24	222	Standard	with rotated handles

Stainless Steel Bubblers, horizontal, electropolished with fill-port, high temperature valves (315°C)							
Catalog #	Vol. (mL)	A mm	B mm	C mm	D mm	Temp. Valve	Special Configuration
98-0272	150	51	108	24	222	High	
96-5006	300	51	187	24	222	High	
96-5007	600	76	163	24	222	High	
96-5008	1000	76	254	24	222	High	

See reverse side for Vertical Stainless Steel Bubblers

Visit www.strem.com for new product information and a searchable catalog.

Strem Chemicals, Inc.
7 Mulliken Way
Newburyport, MA 01950
U.S.A.
Tel: 978.499.1600
Fax: 978.465.3104
Email: info@strem.com

Strem Chemicals, Inc.
15, rue de l'Atome
Zone Industrielle
67800 BISCHHEIM France
Tel: (33) 03 88 62 52 60
Fax: (33) 03 88 62 26 81
Email: info.europe@strem.com

Strem Chemicals, Inc.
Postfach 1215
77672 KEHL
Germany
Tel: 0 78 51/ 7 58 79
Email: info.europe@strem.com

Strem Chemicals UK Ltd.
An Independent Distributor of Strem Chemicals Products
Newton Hall, Town Street
Newton, Cambridge
England CB22 7ZE
Tel: 0845 643 7263
Fax: 0845 643 7362
Email: enquiries@strem.co.uk