

Stainless Steel Bubblers, vertical, electropolished with fill-port, PCTFE valve stem tip (121°C)								
Catalog #	Vol. (mL)	A mm	B mm	C mm	D mm	E mm	Temp. Valve	Special Configuration
96-4151	150	51	108	140	83	13	Standard	
96-4290	300	51	187	140	83	13	Standard	
96-4598	600	76	163	140	83	13	Standard	
96-4998	1000	76	254	140	83	13	Standard	
96-5002	1000	102	165	140	83	13	Standard	
96-5003	1400	102	203	140	83	13	Standard	
96-5001	1800	102	254	140	83	13	Standard	
96-5011	2750	152	188	140	83	13	Standard	
96-4149	150	51	108	140	83	13	Standard	with short dip tube, cut to 5cm from top of bubbler
96-4153	150	51	108	140	83	13	Standard	with rotated handles

Stainless Steel Bubblers, vertical, electropolished with fill-port, high temperature valves (315°C)								
Catalog #	Vol. (mL)	A mm	B mm	C mm	D mm	E mm	Temp. Valve	Special Configuration
98-0271	150	51	108	140	83	13	High	
98-0270	300	51	187	140	83	13	High	
96-4599	600	76	163	140	83	13	High	
96-4996	1000	76	254	140	83	13	High	
98-0276	150	51	108	140	83	13	High	with short dip tube, cut to 1 inch from top of bubbler
98-0280	300	51	187	140	83	13	High	with rotated handles
96-4295	300	51	187	140	83	13	High	with rotated handles, <b>no dip tube</b>
96-4610	600	76	163	140	83	13	High	with rotated handles, <b>no dip tube</b> , stems same height

See reverse side for Horizontal Stainless Steel Bubblers

Visit [www.strem.com](http://www.strem.com) for new product information and a searchable catalog.

**Strem Chemicals, Inc.**  
7 Mulliken Way  
Newburyport, MA 01950  
U.S.A.  
Tel: 978.499.1600  
Fax: 978.465.3104  
Email: [info@strem.com](mailto:info@strem.com)

**Strem Chemicals, Inc.**  
15, rue de l'Atome  
Zone Industrielle  
67800 BISCHHEIM France  
Tel: (33) 03 88 62 52 60  
Fax: (33) 03 88 62 26 81  
Email: [info.europe@strem.com](mailto:info.europe@strem.com)

**Strem Chemicals, Inc.**  
Postfach 1215  
77672 KEHL  
Germany  
Tel: 0 78 51/ 7 58 79  
Email: [info.europe@strem.com](mailto:info.europe@strem.com)

**Strem Chemicals UK Ltd.**  
An Independent Distributor of Strem Chemicals Products  
Newton Hall, Town Street  
Newton, Cambridge  
England CB22 7ZE  
Tel: 0845 643 7263  
Fax: 0845 643 7362  
Email: [enquiries@strem.co.uk](mailto:enquiries@strem.co.uk)

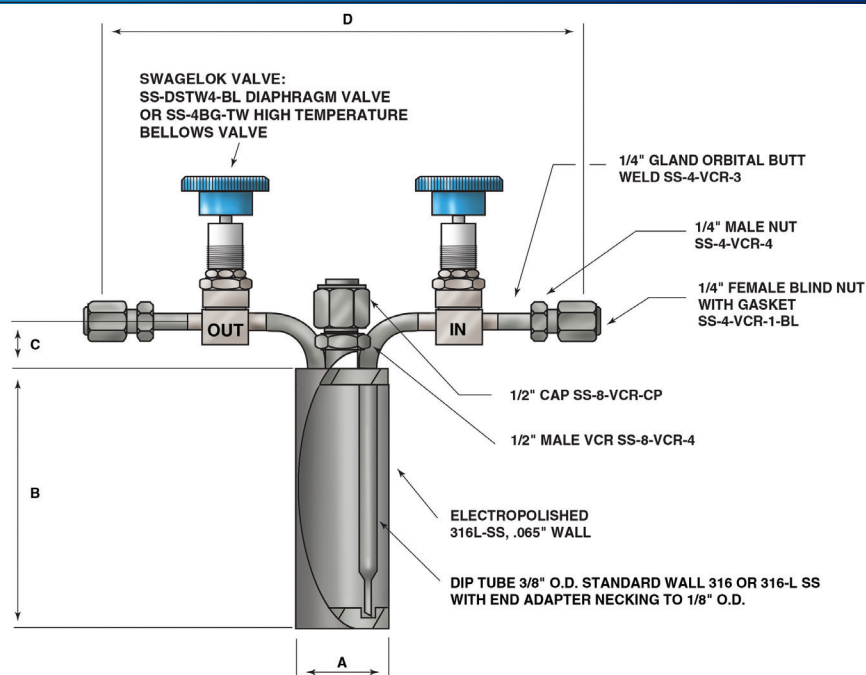

Stainless Steel Bubblers, horizontal, electropolished with fill-port, PCTFE valve stem tip (121°C)							
Catalog #	Vol. (mL)	A mm	B mm	C mm	D mm	Temp. Valve	Special Configuration
96-5151	150	51	108	24	222	Standard	
96-5298	300	51	187	24	222	Standard	
96-5599	600	76	163	24	222	Standard	
96-5998	1000	76	254	24	222	Standard	
96-5004	1800	102	254	24	222	Standard	
98-0273	150	51	108	24	222	Standard	with reversed handles
98-0275	150	51	108	24	222	Standard	with rotated handles

Stainless Steel Bubblers, horizontal, electropolished with fill-port, high temperature valves (315°C)							
Catalog #	Vol. (mL)	A mm	B mm	C mm	D mm	Temp. Valve	Special Configuration
98-0272	150	51	108	24	222	High	
96-5006	300	51	187	24	222	High	
96-5007	600	76	163	24	222	High	
96-5008	1000	76	254	24	222	High	

See reverse side for Vertical Stainless Steel Bubblers

Visit [www.strem.com](http://www.strem.com) for new product information and a searchable catalog.

**Strem Chemicals, Inc.**  
7 Mulliken Way  
Newburyport, MA 01950  
U.S.A.  
Tel: 978.499.1600  
Fax: 978.465.3104  
Email: [info@strem.com](mailto:info@strem.com)

**Strem Chemicals, Inc.**  
15, rue de l'Atome  
Zone Industrielle  
67800 BISCHHEIM France  
Tel: (33) 03 88 62 52 60  
Fax: (33) 03 88 62 26 81  
Email: [info.europe@strem.com](mailto:info.europe@strem.com)

**Strem Chemicals, Inc.**  
Postfach 1215  
77672 KEHL  
Germany  
Tel: 0 78 51/ 7 58 79  
Email: [info.europe@strem.com](mailto:info.europe@strem.com)

**Strem Chemicals UK Ltd.**  
An Independent Distributor of Strem Chemicals Products  
Newton Hall, Town Street  
Newton, Cambridge  
England CB22 7ZE  
Tel: 0845 643 7263  
Fax: 0845 643 7362  
Email: [enquiries@strem.co.uk](mailto:enquiries@strem.co.uk)