

STANDARD ASSEMBLY

96-1070 Swagelok® Cylinder Assembly, 50ml with 1/4" VCR Male Ball Valve and Female Nut for CVD/ALD

1/4" VCR Male Ball Valve rated to 300°F or 148°C



| Catalog # | Item Description | Category | Type | Cleaning | Temperature Rating | Pressure Rating | |
|-----------|--|-----------------|---------------|----------|--------------------|-----------------|----------------------|
| 96-1050 | Swagelok® Cylinder, 50ml | Cylinder Body | Standard | SC-11 | --- | --- | <p>96-1052 Valve</p> |
| 96-1052 | Swagelok® 1/4" Male Ball Valve, VCR Metal Gasket Face Seal Fitting | Valve | Standard | SC-10 | 300°F 148°C | 2500 PSI | |
| 96-1051 | Swagelok® 1/4" Female Nut | Female Nut | Standard | SC-10 | --- | --- | |
| 96-1057 | Swagelok® Stainless 1/4" VCR Silver Plated Gasket Retainer Assembly, 2 pcs | Gasket Assembly | Silver plated | N/A | --- | --- | |

HIGH-TEMP VALVE ASSEMBLY

96-1071 Swagelok® Cylinder Assembly, 50ml with 1/4" VCR Male Bellows-Sealed Valve (High Temp) and Female Nut for CVD/ALD

1/4" VCR Male Bellows-Sealed Valve (High Temp/EP) rated to 600°F or 315°C

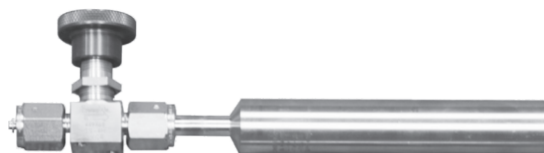

| Catalog # | Item Description | Category | Type | Cleaning | Temperature Rating | Pressure Rating | |
|-----------|--|-----------------|---------------|----------|--------------------|-----------------|----------------------|
| 96-1050 | Swagelok® Cylinder, 50ml | Cylinder Body | Standard | SC-11 | --- | --- | <p>96-1053 Valve</p> |
| 96-1053 | Swagelok® 1/4" Male Bellows-Sealed Valve (High-Temp) VCR Metal Gasket Seal Fitting | Valve | High Temp/EP | SC-11 | 600°F 315°C | 1000 PSI | |
| 96-1051 | Swagelok® 1/4" Female Nut | Female Nut | Standard | SC-10 | --- | --- | |
| 96-1057 | Swagelok® Stainless 1/4" VCR Silver Plated Gasket Retainer Assembly, 2 pcs | Gasket Assembly | Silver plated | N/A | --- | --- | |

STANDARD ASSEMBLY COMPONENTS

Assembly components are not available for individual sale.



Swagelok® Cylinder, 50ml



Swagelok® 1/4" Female Nut



Swagelok® 1/4" Stainless 1/4" VCR Silver Plated Gasket Retainer Assembly

Visit www.strem.com for new product information and a searchable catalog.

Strem Chemicals, Inc.
7 Mulliken Way
Newburyport, MA 01950
U.S.A
Tel: 978.499.1600
Fax: 978.465.3104
Email: info@strem.com

Strem Chemicals, Inc.
15, rue de l'Atome
Zone Industrielle
67800 BISCHHEIM France
Tel: (33) 03 88 62 52 60
Fax: (33) 03 88 62 26 81
Email: info.europe@strem.com

Strem Chemicals, Inc.
Postfach 1215
77672 KEHL
Germany
Tel: 0 78 51/ 7 58 79
Email: info.europe@strem.com

Strem Chemicals UK Ltd.
An Independent Distributor of Strem Chemicals Products
Newton Hall, Town Street
Newton, Cambridge
England CB22 7ZE
Tel: 0845 643 7263
Fax: 0845 643 7362
Email: enquiries@strem.co.uk

ELECTROPOLISHED (EP) ASSEMBLY WITH BALL VALVE

96-1075 Swagelok® Cylinder Assembly, 50ml with 1/4" VCR Male Ball Valve (SC-11 cleaned) and Female Nut, electropolished for CVD/ALD

1/4" VCR Male Ball Valve (EP) rated to 300°F or 148°C



| Catalog # | Item Description | Category | Type | Cleaning | Temperature Rating | Pressure Rating | |
|-----------|---|-----------------|----------|----------|--------------------|-----------------|--|
| 96-1054 | Swagelok® Cylinder, Electropolished, 50ml | Cylinder Body | EP | SC-11 | --- | --- |  <p>96-1059 Valve</p> |
| 96-1059 | Swagelok® 1/4" Male Ball Valve, VCR Metal Gasket Face Seal Fitting, SC-11 cleaned | Valve | EP | SC-11 | 300°F 148°C | 2500 PSI | |
| 96-1056 | Swagelok® 1/4" Female Nut, SC-11 cleaned | Female Nut | EP | SC-11 | --- | --- | |
| 96-1058 | Swagelok® Stainless 1/4" VCR Unplated Gasket Retainer Assembly, 2 pcs | Gasket Assembly | Unplated | N/A | --- | --- | |

ELECTROPOLISHED (EP) ASSEMBLY WITH HIGH-TEMP VALVE

96-1076 Swagelok® Cylinder Assembly, 50ml with 1/4" VCR Male Bellows-Sealed Valve (High Temp) and Female Nut, electropolished for CVD/ALD

1/4" VCR Male Bellows-Sealed Valve (High Temp/EP) rated to 600°F or 315°C



| Catalog # | Item Description | Category | Type | Cleaning | Temperature Rating | Pressure Rating | |
|-----------|---|-----------------|------------------|----------|--------------------|-----------------|--|
| 96-1054 | Swagelok® Cylinder, Electropolished, 50ml | Cylinder Body | EP | SC-11 | --- | --- |  <p>96-1053 Valve</p> |
| 96-1053 | Swagelok® 1/4" Male Bellows-Sealed Valve (High-Temp) VCR Metal Gasket Seal Fitting, SC-11 cleaned | Valve | High Temp/ EP | SC-11 | 600°F 315°C | 1000 PSI | |
| 96-1056 | Swagelok® 1/4" Female Nut, SC-11 cleaned | Female Nut | EP | SC-11 | --- | --- | |
| 96-1058 | Swagelok® Stainless 1/4" VCR Unplated Gasket Retainer Assembly, 2 pcs | Gasket Assembly | Unplated | N/A | --- | --- | |

ELECTROPOLISHED ASSEMBLY COMPONENTS

Assembly components are not available for individual sale.



Swagelok® Cylinder, Electropolished, 50ml



Swagelok® 1/4" Female Nut, SC-11 cleaned



Swagelok® 1/4" Stainless 1/4" VCR Unplated Gasket Retainer Assembly

Visit www.strem.com for new product information and a searchable catalog.

Strem Chemicals, Inc.
7 Mulliken Way
Newburyport, MA 01950
U.S.A
Tel: 978.499.1600
Fax: 978.465.3104
Email: info@strem.com

Strem Chemicals, Inc.
15, rue de l'Atome
Zone Industrielle
67800 BISCHHEIM France
Tel: (33) 03 88 62 52 60
Fax: (33) 03 88 62 26 81
Email: info.europe@strem.com

Strem Chemicals, Inc.
Postfach 1215
77672 KEHL
Germany
Tel: 0 78 51/ 7 58 79
Email: info.europe@strem.com

Strem Chemicals UK Ltd.
An Independent Distributor of Strem Chemicals Products
Newton Hall, Town Street
Newton, Cambridge
England CB22 7ZE
Tel: 0845 643 7263
Fax: 0845 643 7362
Email: enquiries@strem.co.uk

DP VALVE ASSEMBLY - ULTRA HIGH PURITY

96-1077 Swagelok® Cylinder Assembly, 50ml with 1/4" VCR Male DP Valve (Ultra High Purity) and Female Nut, electropolished for CVD/ALD

1/4" VCR Male DP high pressure diaphragm Valve (Ultra High Purity/EP) rated to 50-320°F or 10-148°C

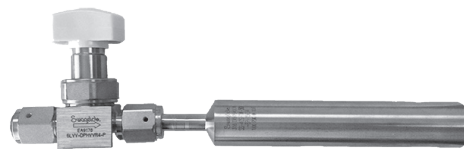

| Catalog # | Item Description | Category | Type | Cleaning | Temperature Rating | Pressure Rating | |
|-----------|--|-----------------|----------------------|----------|----------------------------|-----------------|--|
| 96-1054 | Swagelok® Cylinder, Electropolished 50ml | Cylinder Body | EP | SC-11 | --- | --- |  96-1055 Valve |
| 96-1055 | Swagelok® 1/4" Male DP high pressure diaphragm Valve (Ultra High Purity), polyimide seat, VCR Metal Gasket Seal Fitting, SC-01 cleaned | Valve | Ultra High Purity/EP | SC-01 | 50° - 302°F 10° - 148°C | 3045 PSI | |
| 96-1056 | Swagelok® 1/4" Female Nut, SC-11 cleaned | Female Nut | EP | SC-11 | --- | --- | |
| 96-1058 | Swagelok® Stainless 1/4" VCR Unplated Gasket Retainer Assembly, 2 pcs | Gasket Assembly | Unplated | N/A | --- | --- | |

DP HIGH PRESSURE VALVE ASSEMBLY - HIGH PURITY

96-1078 Swagelok® Cylinder Assembly, 50ml with 1/4" VCR Male DP High Pressure Valve (High Purity), PCTFE seat, VCR Metal Gasket Seal Fitting, Round Handle

1/4" VCR Male DP high pressure diaphragm Valve (High Purity/EP) rated to 250°F or 121°C



| Catalog # | Item Description | Category | Type | Cleaning | Temperature Rating | Pressure Rating | |
|-----------|--|-----------------|----------------|----------|--------------------|-----------------|--|
| 96-1054 | Swagelok® Cylinder, Electropolished, 50ml | Cylinder Body | EP | SC-11 | --- | --- |  96-1060 Valve |
| 96-1060 | Swagelok® 1/4" Male DP high pressure diaphragm Valve (High Purity), PCTFE seat, VCR Metal Gasket Seal Fitting, Round handle, SC-11 cleaned | Valve | High Purity/EP | SC-11 | 250°F 121°C | 2800 PSI | |
| 96-1056 | Swagelok® 1/4" Female Nut, SC-11 cleaned | Female Nut | EP | SC-11 | --- | --- | |
| 96-1058 | Swagelok® Stainless 1/4" VCR Unplated Gasket Retainer Assembly, 2 pcs | Gasket Assembly | Unplated | N/A | --- | --- | |

DP VALVE ASSEMBLY COMPONENTS

Assembly components are not available for individual sale.



Swagelok® Cylinder, Electropolished, 50ml



Swagelok® 1/4" Female Nut, SC-11 cleaned



Swagelok® 1/4" Stainless 1/4" VCR Unplated Gasket Retainer Assembly

Visit www.strem.com for new product information and a searchable catalog.

Strem Chemicals, Inc.
 7 Mulliken Way
 Newburyport, MA 01950
 U.S.A
 Tel: 978.499.1600
 Fax: 978.465.3104
 Email: info@strem.com

Strem Chemicals, Inc.
 15, rue de l'Atome
 Zone Industrielle
 67800 BISCHHEIM France
 Tel: (33) 03 88 62 52 60
 Fax: (33) 03 88 62 26 81
 Email: info.europe@strem.com

Strem Chemicals, Inc.
 Postfach 1215
 77672 KEHL
 Germany
 Tel: 0 78 51/ 7 58 79
 Email: info.europe@strem.com

Strem Chemicals UK Ltd.
 An Independent Distributor of Strem Chemicals Products
 Newton Hall, Town Street
 Newton, Cambridge
 England CB22 7ZE
 Tel: 0845 643 7263
 Fax: 0845 643 7362
 Email: enquiries@strem.co.uk

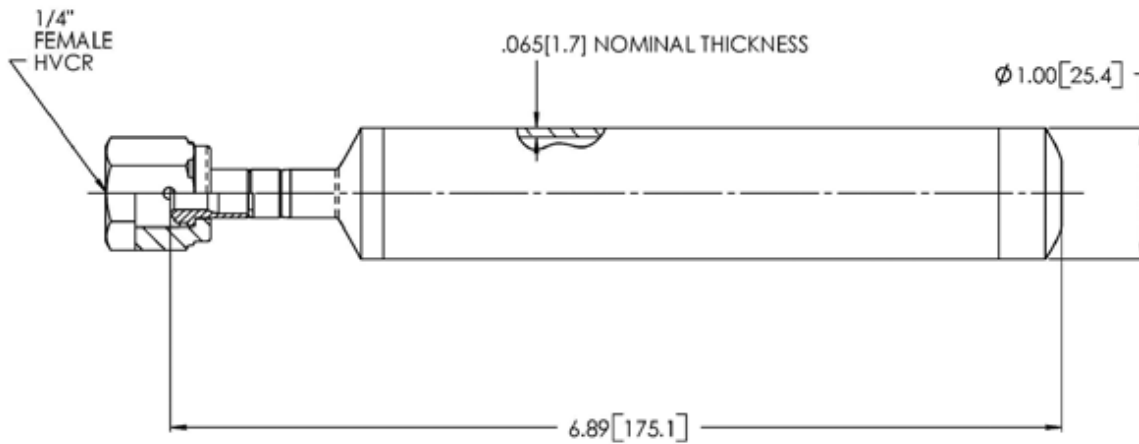

- Drawing is not to scale
- Dimensions are in inches [millimeters in brackets]
- Drawing subject to change without notice

Definition of Swagelok® Cleaning Codes

| | |
|--------------|---|
| SC-01 | Ultra High Purity Process - DI water cleaning system is closed to the environment and limits contamination. A series of ultrasonic washing and multistage DI water rinse before drying. |
| SC-10 | Standard Cleaning - Basic industrial procedures. |
| SC-11 | Special Cleaning - Multistep process that ensures thorough cleaning, rinsing, draining and drying. |

Swagelok® Trademark is owned by Swagelok Company. Registered user in Canada: SWAGELOK Canada, Ltd. SWAGELOK AG is an authorized user in Switzerland of the SWAGELOK trademark.

ADDITIONAL CYLINDERS FOR ALD

95-4154 Stainless steel cylinder, 200ml, single vertical stem, electropolished with fill-port, PCTFE valve stem tip, DOT 4B, UN stamped

| | |
|-------------------------|-------------|
| Cylinder Size | 2" Diameter |
| Cylinder Working Volume | 200ml |
| Cylinder Total Volume | 233ml |
| Cylinder Tare Weight | 2.75 lbs |
| Design Pressure | 300PSI |
| Test Pressure | 600PSI |
| Design Temperature | 250°F/121°C |
| Fillport | 1/2" MCVR |
| Outlet Valve | SS-DSTW4 |
| D.O.T. Specification | 4B-300 |

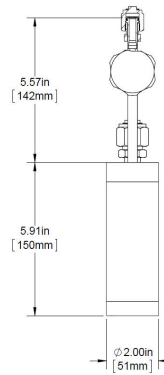

95-0281 Stainless steel cylinder, 125ml, horizontal in line, with angled Bellows valve (150°C), DOT 4B, UN stamped

| | |
|-------------------------|-------------------------|
| Cylinder Size | 2.5" Diameter |
| Cylinder Working Volume | 125ml |
| Cylinder Total Volume | 137ml |
| Cylinder Tare Weight | 1.89 lbs |
| Design Pressure | 260PSI |
| Test Pressure | 520PSI |
| Design Temperature | -10 to 150 C* |
| Inlet Valve | FUJIKIN, FUB-81-6.35-PI |
| D.O.T. Specification | 4B-260 |

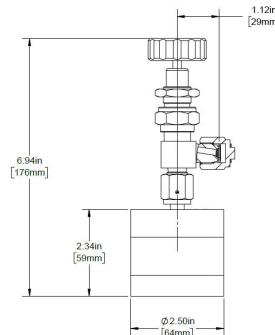

* The FUB-81-6.35-PI valve is rated for 150°C but per the manufacturer, it can be heated to 175°C if the total number of cycles does not exceed 200 annually during usage

Visit www.strem.com for new product information and a searchable catalog.

Strem Chemicals, Inc.
7 Mulliken Way
Newburyport, MA 01950
U.S.A
Tel: 978.499.1600
Fax: 978.465.3104
Email: info@strem.com

Strem Chemicals, Inc.
15, rue de l'Atome
Zone Industrielle
67800 BISCHHEIM France
Tel: (33) 03 88 62 52 60
Fax: (33) 03 88 62 26 81
Email: info.europe@strem.com

Strem Chemicals, Inc.
Postfach 1215
77672 KEHL
Germany
Tel: 0 78 51/ 7 58 79
Email: info.europe@strem.com

Strem Chemicals UK Ltd.
An Independent Distributor of Strem Chemicals Products
Newton Hall, Town Street
Newton, Cambridge
England CB22 7ZE
Tel: 0845 643 7263
Fax: 0845 643 7362
Email: enquiries@strem.co.uk