

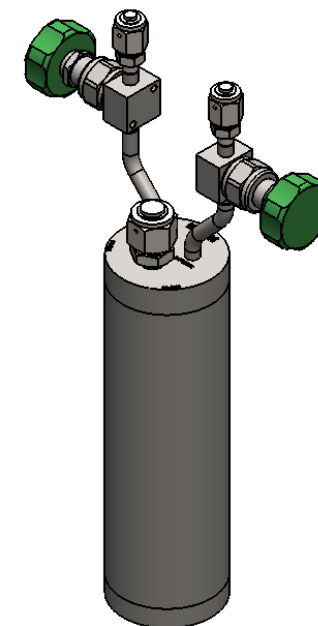

TECHNICAL NOTES: STREM ITEM NUMBER 95-4998

STAINLESS STEEL BUBBLER, 1000ml, VERTICAL, ELECTROPOLISHED WITH FILL-PORT, PCTFE VALVE STEM TIP, DOT 4B, UN STAMPED

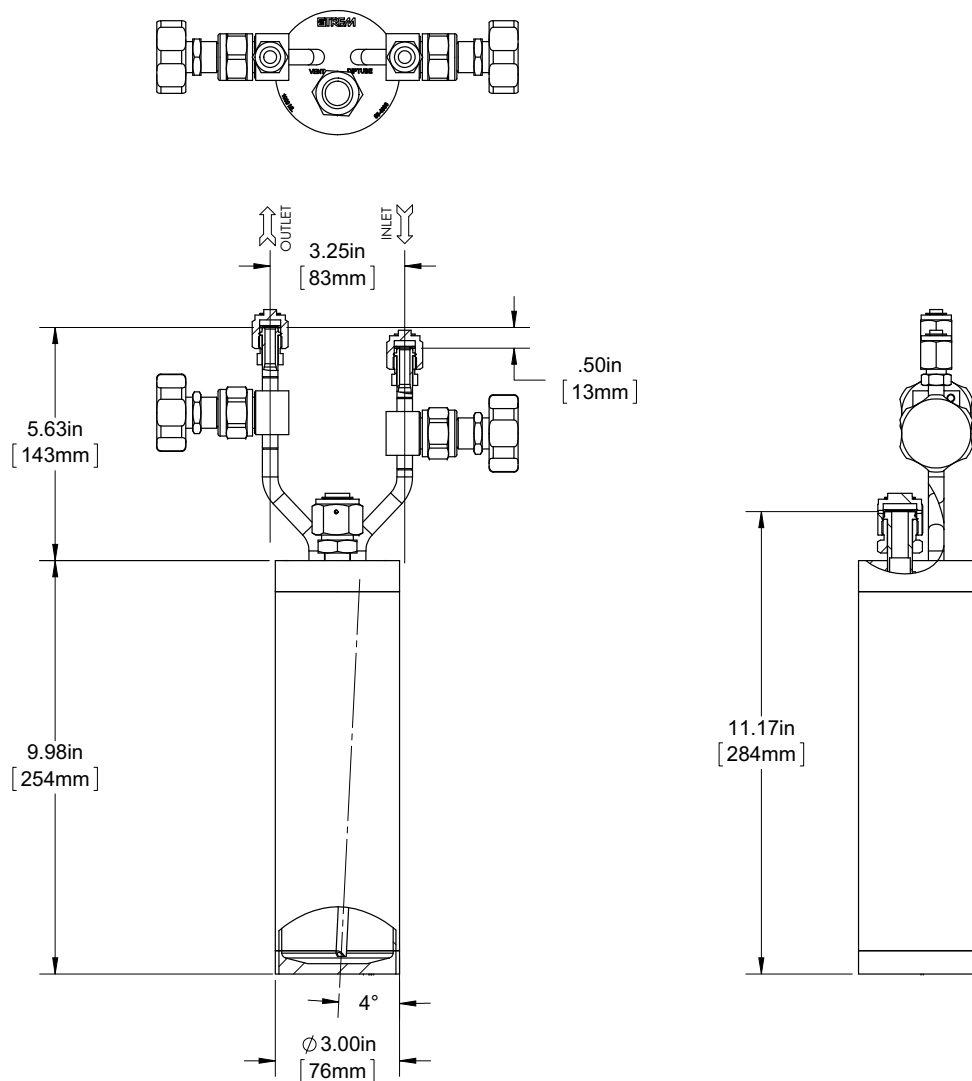

REV.	DATE
01	07/15/2015

DESIGN SPECIFICATION	
CYLINDER MODEL	95-4998
CYLINDER SIZE	3" DIAMETER
CYLINDER WORKING VOLUME	1000ml
CYLINDER TOTAL VOLUME	1020ml
CYLINDER TARE WEIGHT	5.86 lbs
DESIGN PRESSURE	260 psi
TEST PRESSURE	520 psi
DESIGN TEMPERATURE	250F/121C
INTERNAL FINISH	10ra, MIRROR, ELECTROPOLISH
EXTERNAL FINISH	10ra, MIRROR, ELECTROPOLISH
FILLPORT	SWAGELOK, 1/2 VCR
INLET VALVE	SWAGELOK, SS-DSTW4
OUTLET VALVE	SWAGELOK, SS-DSTW4
THERMOWELL	NO
DIPTUBE	YES
MATERIAL OF CONSTRUCTION	316L SS
D.O.T. SPECIFICATION	4B-260
TOLERANCE (UNLESS OTHERWISE SPECIFIED)	±.060

NOTICE OF CONFIDENTIAL INFORMATION

©COPYRIGHT 2014 STREM CHEMICALS, INC. ALL RIGHTS RESERVED.

THIS IMAGE IS PROTECTED UNDER FEDERAL AND INTERNATIONAL COPYRIGHT LAW. NO PART OF THIS IMAGE MAY BE REPRODUCED, STORED OR TRANSMITTED IN ANY FORM BY ANY MEANS WITHOUT THE PRIOR WRITTEN CONSENT OF STREM CHEMICALS, INC. THIS IMAGE IS PROVIDED SOLELY AS A DEPICTION OF THE ITEM DESCRIBED. THERE IS NO RIGHT OR LICENSE GRANTED HEREIN TO CONSTRUCT THE ITEM DEPICTED IN THE IMAGE OR TO CREATE DERIVATIVE WORKS OF THE SAME WITHOUT THE PRIOR WRITTEN CONSENT OF STREM CHEMICALS, INC. ALL SUCH RIGHTS ARE EXPRESSLY RESERVED.