

98-7500 EvoluChem™ PhotoRedOx Box, 110V,
Type A plug (USA electrical outlet)

98-7501 EvoluChem™ PhotoRedOx Box, 220V,
Type C plug (EU electrical outlet)

*Items required but not included with purchase: 1) light source; 2) photochemistry vial holder.
These items are sold separately.*



The EvoluChem™ PhotoRedOx Box device is designed to facilitate photochemical experiments. This device is compatible with most vial formats (see related Photochemistry holders: 98-7600, 98-7650, 98-7700, 98-7780, or 98-7790). Its compact design allows for use with any stirring plate. A built-in fan keeps the reaction conditions at room temperature.

Features

- Light source (See 98-7950, 98-7955, 98-7975, 98-7980, 98-7820, 98-7880, 98-7900, 98-7905, 98-7800, 98-7805, 98-7990, 98-7991, 98-8010 & 98-8011)
- Photochemistry chamber to evenly distribute light
- Flexible vial formats
- Magnetic stirring on standard stirring plate
- Cooling by fan to maintain experiment at room temperature
- Pre-designed array of catalysts and reagents available

Benefits

- Easy set-up on a standard stirring plate
- Performs up to 32 reaction conditions simultaneously
- Individually sealed vials enable flexible study design
- Save your substrate using low scale reaction conditions
- Save time on optimization

Unique Geometry to focus light on samples

EvoluChem™ PhotoRedOx Box is equipped with several mirrors that direct and distribute the light toward the samples. The geometry of the box enables parallel reaction with homogeneous light exposure.

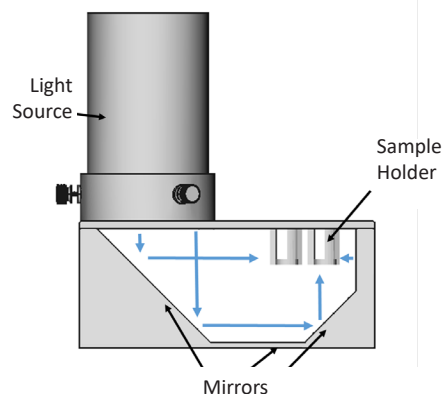

Better Heat Management

The position of the light source on the side of the samples reduces the amount of heat directed to the samples. The embedded fan eliminates any remaining heat.

Easy set-up and compact design

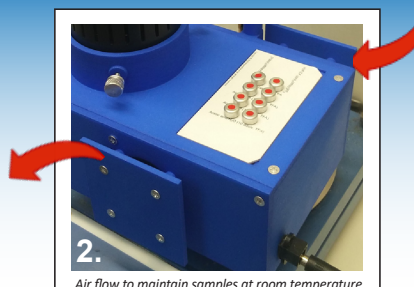
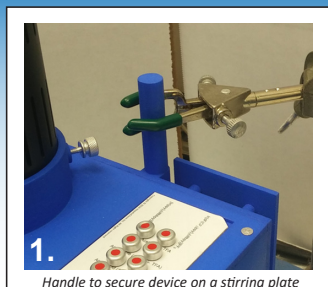

EvoluChem™ PhotoRedOx Box TC (Temperature Controlled)

98-7550 EvoluChem™ PhotoRedOx Box (Temperature controlled), 110V,
Type A plug (USA electrical outlet)

98-7551 EvoluChem™ PhotoRedOx Box (Temperature controlled), 220V,
Type C plug (EU electrical outlet)



The temperature controlled photoredox device allows to perform photo-catalytic reactions at controlled temperature from -20°C to 80°C . The device uses the same design than our standard photoredox box with mirror that direct the light to samples holders allowing the performance of multiple reaction conditions simultaneously. However it is possible to heat and cool the reaction using a thermostatic fluid such as water that recirculates from a chiller/heater unit.

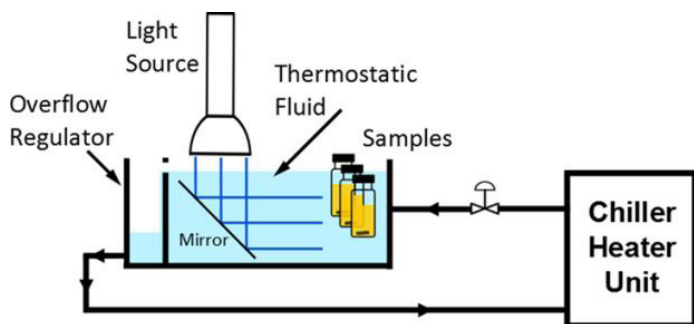

Irradiance vs Thermostatic fluid

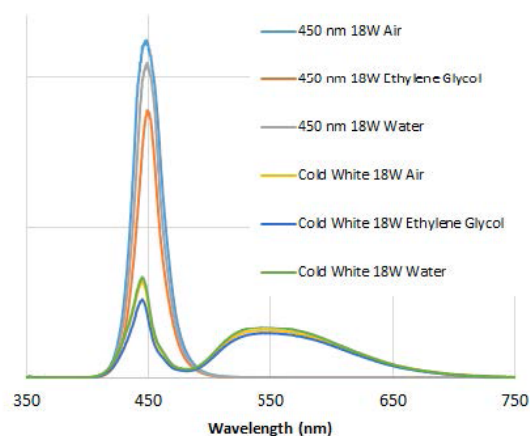

Features

- Fits many light sources (EvoluChem 18W or Kessil blue 34W)
- Photochemistry chamber to evenly distribute light
- Flexible format vials (from 0.3 ml to 20 ml)
- Flow reactor available
- Stirring on magnetic stirring plate
- External recirculator needed to heat or chill reaction vessel

EvoluChem™ Light Proofing Upgrade

98-7850 EvoluChem™ Light Proofing Upgrade

Items required but not included with purchase: 1) PhotoRedOx Box; 2) light source; 3) photochemistry vial holder. These items are sold separately.

The PhotoRedOx Box has been designed to limit the exposure to light during experiment.

However when using light spectrum below 500nm, repetitive exposure to light should be avoided. In addition to personal protective equipment, we offer upgrade kit to dramatically reduce the light leaking from the device.

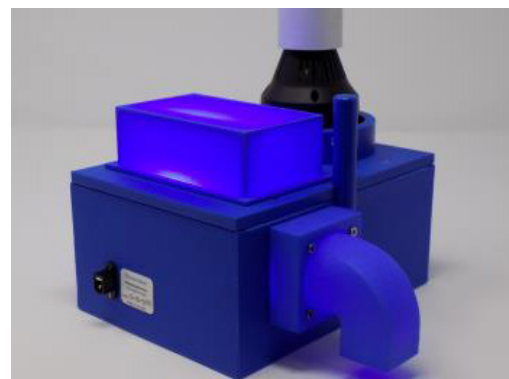
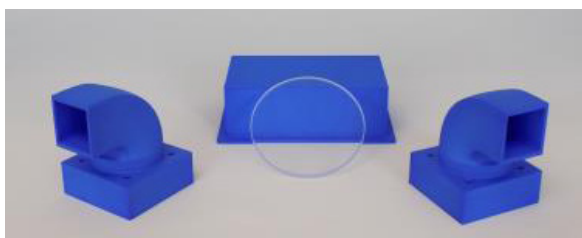

EvoluChem™ PhotoRedOx Box Photochemistry Holders



32 x 0.3ml vials



8 x 2ml vials



8 x 8ml vials



2 x 20 ml vials



8 x 4 ml vials

98-7600	EvoluChem™ PhotoRedOx Box Photochemistry Holder - 32 x 0.3ml vials	1 pc
98-7650	EvoluChem™ PhotoRedOx Box Photochemistry Holder - 8 x 2ml vials	1 pc
98-7700	EvoluChem™ PhotoRedOx Box Photochemistry Holder - 8 x 8ml vials	1 pc
98-7780	EvoluChem™ PhotoRedOx Box Photochemistry Holder - 2 x 20 ml vials	1 pc
98-7790	EvoluChem™ PhotoRedOx Box Photochemistry Holder - 8 x 4 ml vials	1 pc

EvoluChem™ PhotoRedOx Box Light Source

The EvoluChem PhotoRedOx Box requires a light source. The below light sources are compatible and sold separately.

98-7950	EvoluChem™ PhotoRedOx Box Light Source - Wavelength 365nm, Electric Power 18W, 110V, Type A plug (USA electrical outlet)	1 pc
98-7955	EvoluChem PhotoRedOx Box Light Source - Wavelength 365nm, Electric Power 18W, 220V, Type C plug (EU electrical outlet)	1 pc
98-7975	EvoluChem PhotoRedOx Box Light Source - Electric Power PAR20-18W, LG, Wavelength 380nm, 25 degrees, 110V Type A plug (USA electrical outlet)	1 pc
98-7980	EvoluChem PhotoRedOx Box Light Source - Electric Power PAR20-18W, LG, Wavelength 380nm, 25 degrees, 220V, Type C plug (EU electrical outlet)	1 pc
98-7820	EvoluChem™ PhotoRedOx Box Light Source - Wavelength 405nm, Electric Power 18W, 110V, Type A plug (USA electrical outlet)	1 pc
98-7880	EvoluChem PhotoRedOx Box Light Source - Wavelength 405nm, Electric Power 18W, 220V, Type C plug (EU electrical outlet)	1 pc
98-7900	EvoluChem PhotoRedOx Box Light Source - Wavelength 425nm, Electric Power 18W, 110V, Type A plug (USA electrical outlet)	1 pc
98-7905	EvoluChem PhotoRedOx Box Light Source - Wavelength 425nm, Electric Power 18W, 220V, Type C plug (EU electrical outlet)	1 pc
98-7800	EvoluChem™ PhotoRedOx Box Light Source - Wavelength 450nm, Electric Power 18W, 110V, Type A plug (USA electrical outlet)	1 pc
98-7805	EvoluChem PhotoRedOx Box Light Source - Wavelength 450nm, Electric Power 18W, 220V, Type C plug (EU electrical outlet)	1 pc
98-7990	EvoluChem™ PhotoRedOx Box Light Source - Wavelength 525nm, Electric Power 18W, 110V, Type A plug (USA electrical outlet)	1 pc
98-7991	EvoluChem™ PhotoRedOx Box Light Source - Wavelength 525nm, Electric Power 18W, 220V, Type C plug (EU electrical outlet)	1 pc
98-8010	EvoluChem™ PhotoRedOx Box Light Source - Wavelength 650nm, Electric Power 18W, 110V, Type A plug (USA electrical outlet)	1 pc
98-8011	EvoluChem™ PhotoRedOx Box Light Source - Wavelength 650nm, Electric Power 18W, 220V, Type C plug (EU electrical outlet)	1 pc

EvoluChem™ PhotoRedOx Box Light Source

The EvoluChem™ light source is designed specifically for photocatalytic chemistry applications. It fits the EvoluChem™ PhotoRedOx Box (98-7500, 98-7501, 98-7550, or 98-7551) and is designed to irradiate all samples with maximum efficiency.

The LED chips are selected for specific wavelengths. Although the total power of LED light is important, it is essential to estimate the amount of light that actually goes on the sample. If the light is spread over a large area the density of light (irradiance) on sample will be little. Therefore we designed the EvoluChem™ LEDs to focus the light toward the samples at a 25° angle.

General Specifications, Light Power vs. Irradiance	
Power Consumption	18W
Input Voltage	100-240 VAC
Beam Angle	25°
Wavelength Options	365nm, 380nm, 405nm, 425nm, 450nm, 525nm, 650nm
LED	Cree XPE (98-7800) EPILED (98-7900) LG (98-7950)



Directly compatible with PhotoRedOx Box



Light Source

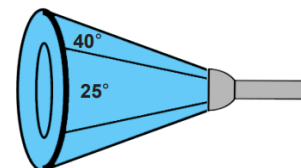

Focused light beam

EvoluChem™ Photocatalyst Kits

96-7510 EvoluChem™ Photochemical Methylation Array Kit

1 kit

This kit is compatible with our PhotoRedOx Boxes (98-7500, 98-7501, 98-7550 & 98-7551).

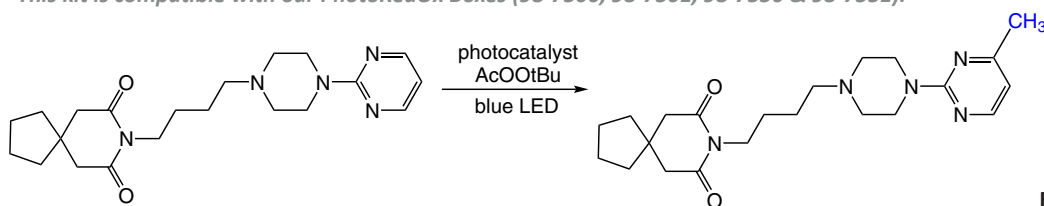

Reference: *Chem. Soc. Rev.*, 2016, 45, 546-576.

Kit Protocol:

The typical protocol is performed in a 0.05 Mol/l concentration reaction condition using a substrate solution of four different solvents. Each sealed reaction vial contains 0.1 μmol of photocatalyst and 12.5 μmol of *tert*-butyl peracetate. Based on the concentration of the substrate stock solution and the volume added, the following reaction stoichiometry can be achieved with the standard photomethylation kit.

	77-0425	77-0410
50/50 Acetonitrile/TFA	5 equiv. <i>tert</i> -butyl peracetic acid	
Acetonitrile (10 equiv. TFA)		
Acetic acid (10 equiv. TFA)		
Acetic acid/H ₂ O (10 equiv. TFA)		

Kit Contents

Description	Quantity	Amount
(4,4'-Di- <i>t</i> -butyl-2,2'-bipyridine)bis[3,5-difluoro-2-[5-(trifluoromethyl-2-pyridinyl-kN)phenyl-kC]iridium(III) hexafluorophosphate, 99% (77-0425) / <i>tert</i> -butyl peracetate	8 vials	0.1 μmol/12.5 μmol
(4,4'-Di- <i>t</i> -butyl-2,2'-bipyridine)bis[2-(2-pyridinyl-kN)phenyl-kC]iridium(III) hexafluorophosphate, 99% (77-0410) / <i>tert</i> -butyl peracetate	8 vials	0.1 μmol/12.5 μmol
50/50 Acetonitrile/ trifluoroacetic acid	1 vial	1 ml
Acetonitrile (10 equiv. trifluoroacetic acid*)	1 vial	1 ml
Acetic acid (10 equiv. trifluoroacetic acid*)	1 vial	1 ml
Acetic acid/water (10 equiv. trifluoroacetic acid*)	1 vial	1 ml
Substrate stock vial 1	1 vial	--
Substrate stock vial 2	1 vial	--
Substrate stock vial 3	1 vial	--
Substrate stock vial 4	1 vial	--

This kit is compatible with our PhotoRedOx Boxes (98-7500, 98-7501, 98-7550 & 98-7551).

Product Overview:

The trifluoroborate alkylation reaction (Minisci reaction)¹ is a powerful late stage functionalization tool. Our kit allows convenient, one-step production of eight different analogues of a lead compound in mg quantities. Each reaction vial contains 75 μmol of trifluoroborate alkylation reagent (pre-weighed) and a stirring bar to react with 50 μmol of substrate. C-H functionalization will primarily occur on electron-deficient heteroarenes at one or several positions.

Kit Contents (16 reaction vials total):

- 2 reaction vials of BF₃K reagents (75 μmol)
- 2 reaction vials of K₂S₂O₈ (100 μmol)
- 2 vials of photocatalysts
- 2 vials of TFA

Kit Protocol

For each kit, 4mL of a 0.1 M solution of substrate (400 μmol total) in DMSO is prepared with 8.98 mg photocatalyst Ir(dF-CF₃-ppy)₂(dtbbpy) (77-0425) (8 μmol, 2 mol%) and trifluoroacetic acid (153 μL, 5 equiv) included. The solution is sparged with nitrogen. Each vial contains 27.0mg K₂S₂O₈ (100 μmol, 2 equiv.) and 1.5 equiv. BF₃K reagent (75 μmol) in 2ml vials equipped with a stir bar and Teflon septa. Alternatively for methylation, vials contain 39.9 μL of tert-butyl peracetate (TBPA). Vials are prepared under argon. 500μL of substrate solution is added via syringe and the vial is placed in PhotoRedOx Box (98-7500) equipped with light source. Reaction is stirred for 2-24 hr.

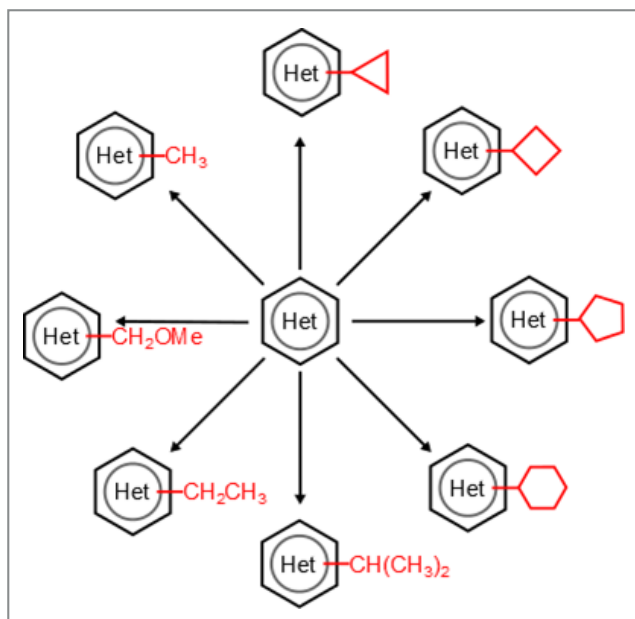

Photocatalytic Alkylation Reagents (2 Vials of each)

	cyclopropyl	cyclobutyl	cyclopentyl	cyclohexyl	ethyl	isopropyl	methoxy methyl	<i>t</i> -butyl peracetate
MW (g/mol)	147.98	162.00	176.03	190.06	135.97	149.99	151.97	132.16
CAS #	1065010-87-8	1065010-88-9	1040745-70-7	446065-11-8	44248-07-9	1041642-13-0	910251-11-5	107-71-1

References:

1. *Chem. Sci.*, **2017**, *8* (39), 3512-3522.
2. *Chem. Soc. Rev.*, **2016**, *45*, 546-576.

Iridium/Nickel Photoredox Kits

Photoredox chemistry has been reported in literature using a wide range of catalysts and reagents. However, often these reactions are highly substrate, solvent and base specific. In order to facilitate the screening of common photochemistry reactions, HepatoChem has released a series of kits combining common Iridium, Nickel, ligand and base combinations to achieve successful cross-coupling transformations.

Ir/Ni Catalysis Versatility:

Depending on the ligand, base and solvent, the Ir/Ni catalytic systems can perform different cross-coupling reaction.

C-C Coupling

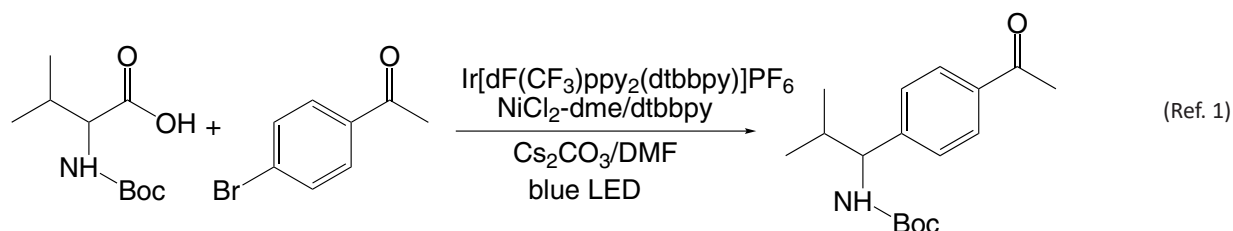

C-N Coupling

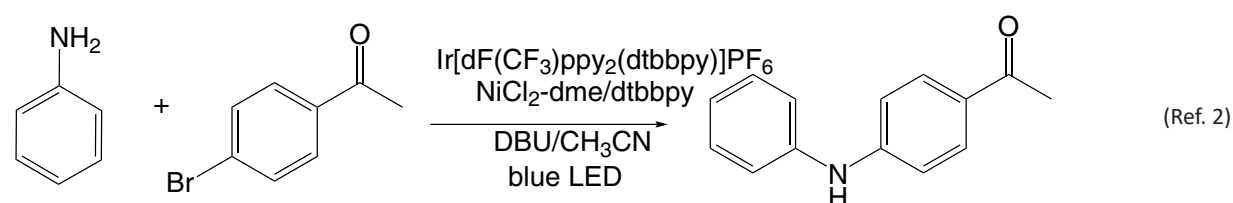

C-O Coupling

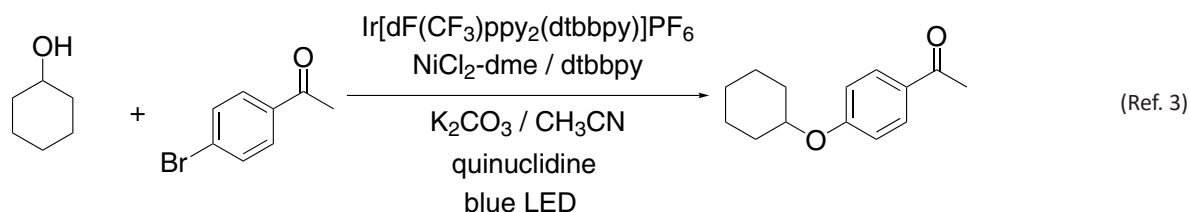

Several Kits Available

Standard Protocol:

5 μmol of substrates in 100 μl solvent with Ir catalyst (2 mol %), $\text{NiCl}_2 \cdot \text{dme}$ (10 mol %), ligand (10 mol %), and 3 equivalent of base.

Features:

- 0.3ml vial with crimp cap and stirring bar
- Specifically designed for photchemistry device
- Pre-weighed reagents and catalysts
- Temperature maintained at RT
- Pre-designed or custom arrays available
- Reagents are packaged under inert atmosphere

References:

1. *Science* **2014**, *345*, 437-440.
2. *Angew. Chemie*, **2016**, *55*, 13219-13223.
3. *Nature* **2015**, *524*, 330-334.

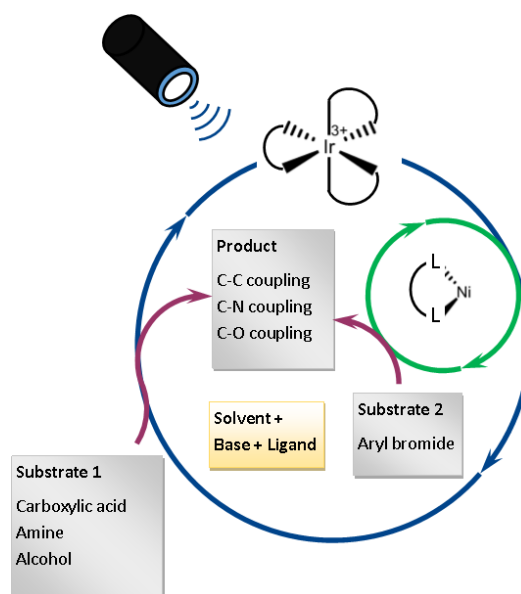

Iridium/Nickel Photoredox Kits (continued)

Results Summary:

Selection of base and solvent is important to find the condition for appropriate coupling (5 μmol per reaction/100 μL scale)

Reaction Type	Substrates	Solvent	Base			
			Cs ₂ CO ₃	K ₃ PO ₄	DABCO	DBU
C-C coupling through decarboxylation	Boc-Val 4-bromoacetophenone	DMF	✓	✓		
C-N coupling (secondary amines)	Pyrolidine 4-bromoacetophenone	DMA			✓	
C-N coupling (aromatic amine/secondary amine)	Indoline 4-bromoacetophenone	DMA		✓		
C-N coupling (aromatic amine)	Aniline 4-bromoacetophenone	ACN			✓	✓

96-7520 EvoluChem™ Iridium/Nickel PhotoRedOx Base and Solvent Screening Kit 1

1 kit

This kit is compatible with our PhotoRedOx Boxes (98-7500, 98-7501, 98-7550 & 98-7551).

Kit Contents:

This kit contains 77-0425 (2 mol%), Ni/Ligand (10 mol%) and base (3 eq)

	Cs ₂ CO ₃	K ₃ PO ₄	K ₂ HPO ₄	KOH	Li ₂ CO ₃	K ₂ CO ₃	DABCO	DBU
Solvent A	2 sets of 8 conditions with 8 different bases per kit (16 total vials) 5 μmol of substrates in 100 μl solvent 77-0425 (2 mol%), Ni/Ligand (10 mol%) and base (3 eq)							
Solvent B								

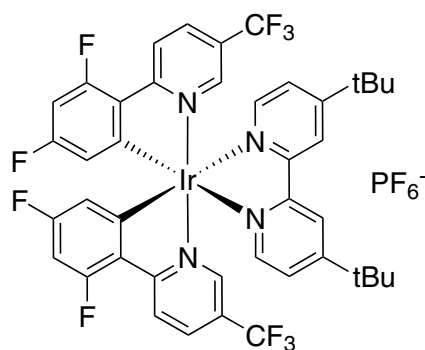

Iridium Catalyst: 77-0425

Suggested Solvents (not included)

1. ACN
2. DMF
3. DMA
4. DMSO

EvoluChem™ Iridium/Nickel Photoredox Kits

96-7530 EvoluChem™ Iridium/Nickel PhotoRedOx Base and Ligand Screening Kit 1

1 kit

This kit is compatible with our PhotoRedOx Boxes (98-7500, 98-7501, 98-7550 & 98-7551).

Kit Contents:

This kit contains 77-0425 (2 mol%), Ni/Ligand (10 mol%) and base (3 eq)

	Cs ₂ CO ₃	K ₃ PO ₄	K ₂ HPO ₄	K ₂ CO ₃
dtbbpy	2 sets of 16 conditions with 4 bases and 4 ligands per kit (32 total vials) 5 μmol of substrates in 100 μl solvent 77-0425 (2 mol%), Ni/Ligand (10 mol%) and base (3 eq)			
bphen				
(MeO) ₂ bpy				
biox				

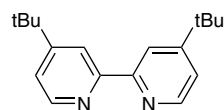
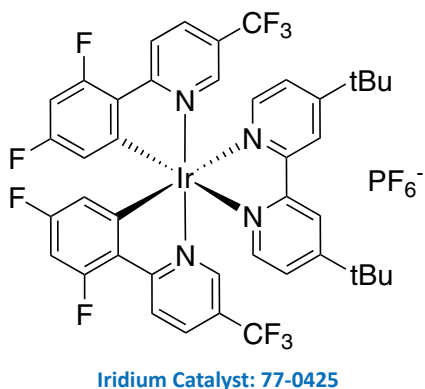

Nitrogen Ligand: dtbbpy

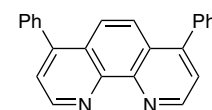

Nitrogen Ligand: bphen

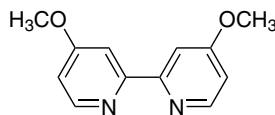

Nitrogen Ligand: (MeO)₂bpy

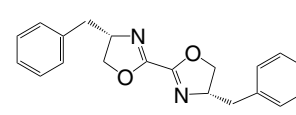

Nitrogen Ligand: biox

96-7540 EvoluChem™ Iridium/Nickel PhotoRedOx Base and Ligand Screening Kit 2

1 kit

This kit is compatible with our PhotoRedOx Boxes (98-7500, 98-7501, 98-7550 & 98-7551).

Kit Contents:

This kit contains 77-0425 (2 mol%), Ni/Ligand (10 mol%) and base (3 eq)

	Cs ₂ CO ₃	K ₃ PO ₄	K ₂ HPO ₄	K ₂ CO ₃	DABCO	DBU
dtbbpy	2 sets of 24 conditions with 6 bases and 4 ligands per kit (48 total vials) 5 μmol of substrates in 100 μl solvent 77-0425 (2 mol%), Ni/Ligand (10 mol%) and base (3 eq)					
bphen						
(MeO) ₂ bpy						
biox						

See catalyst and ligand structures with 96-7530.

EvoluChem™ Iridium/Nickel Photoredox Kits

96-7550 EvoluChem™ Iridium/Nickel PhotoRedOx \ Base and Iridium Catalyst Screening Kit

1 kit

This kit is compatible with our PhotoRedOx Boxes (98-7500, 98-7501, 98-7550 & 98-7551).

Kit Contents:

This kit contains Ir catalyst (2 mol%), Ni/Ligand (10 mol%) and base (3 eq)

	Cs ₂ CO ₃	CsF	DBU
77-0425	2 sets of 18 conditions with 3 bases and 6 Ir catalysts per kit (36 total vials) 5 μmol of substrates in 100 μl solvent Ir catalyst (2 mol%), Ni/Ligand (10 mol%) and base (3 eq)		
77-0410			
77-0453			
77-7030			
77-0218			
77-0330			

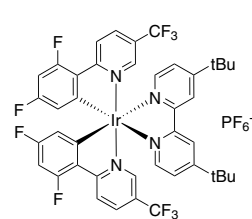

77-0425

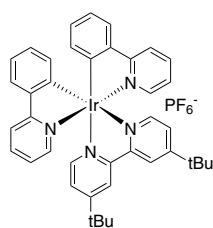

77-0410

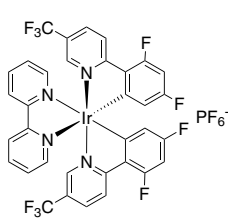

77-0453

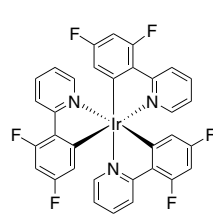

77-7030

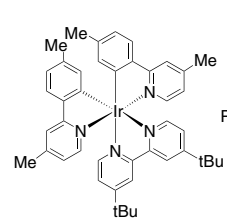

77-0218

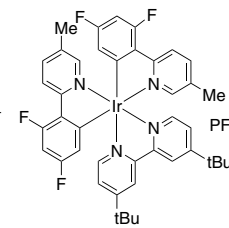

77-0330

96-7570 EvoluChem™ Iridium/Nickel PhotoRedOx Base and Solvent Screening Kit 2 (C-O coupling)

1 kit

This kit is compatible with our PhotoRedOx Boxes (98-7500, 98-7501, 98-7550 & 98-7551).

Kit Contents:

This kit contains 2 sets of 8 reaction conditions per kit (16 total vials) with 77-0425 (1 mol%), Ni/Ligand and quinuclidine

Condition 1	Condition 2	Condition 3	Condition 4	Condition 5	Condition 6	Condition 7	Condition 8
Cs ₂ CO ₃ 1.5 eq.	K ₃ PO ₄ 1.5 eq.	K ₂ CO ₃ 1.5 eq.	K ₂ CO ₃ 1.5 eq.	K ₂ CO ₃ 1.5 eq.	DABCO 1.5 eq.	Quinuclidine 1.5 eq.	No Base Control
NiCl ₂ -dme/ dtbbpy 5 mol%	NiCl ₂ -dme/ dtbbpy 5 mol%	NiCl ₂ -dme/ dtbbpy 5 mol%	NiCl ₂ -dme/ dtbbpy 2.5 mol%	NiCl ₂ -dme/ dtbbpy 1.25 mol%	NiCl ₂ -dme/ dtbbpy 5 mol%	NiCl ₂ -dme/ dtbbpy 5 mol%	NiCl ₂ -dme/dtbbpy 5 mol%
Quinuclidine 10 mol%, 77-0425 1 mol%							

Availability & Shipping

Our products are available globally in various sizes including bulk shipping.

For a complete listing of the Strem Catalog products and catalysis applications, please visit strem.com or contact our team today info@ascensuspecialties.com.

Collaboration

Sold in collaboration with HepatoChem

