

STANDARD ASSEMBLY

96-1070 Swagelok® Cylinder Assembly, 50ml with 1/4" VCR Male Ball Valve and Female Nut for CVD/ALD

1/4" VCR Male Ball Valve rated to 300°F or 148°C



Catalog #	Item Description	Category	Type	Cleaning	Temperature Rating	Pressure Rating	
96-1050	Swagelok® Cylinder, 50ml	Cylinder Body	Standard	SC-11	---	---	<p>96-1052 Valve</p>
96-1052	Swagelok® 1/4" Male Ball Valve, VCR Metal Gasket Face Seal Fitting	Valve	Standard	SC-10	300°F 148°C	2500 PSI	
96-1051	Swagelok® 1/4" Female Nut	Female Nut	Standard	SC-10	---	---	
96-1057	Swagelok® Stainless 1/4" VCR Silver Plated Gasket Retainer Assembly, 2 pcs	Gasket Assembly	Silver plated	N/A	---	---	

HIGH-TEMP VALVE ASSEMBLY

96-1071 Swagelok® Cylinder Assembly, 50ml with 1/4" VCR Male Bellows-Sealed Valve (High Temp) and Female Nut for CVD/ALD

1/4" VCR Male Bellows-Sealed Valve (High Temp/EP) rated to 600°F or 315°C

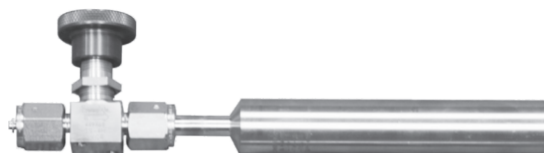

Catalog #	Item Description	Category	Type	Cleaning	Temperature Rating	Pressure Rating	
96-1050	Swagelok® Cylinder, 50ml	Cylinder Body	Standard	SC-11	---	---	<p>96-1053 Valve</p>
96-1053	Swagelok® 1/4" Male Bellows-Sealed Valve (High-Temp) VCR Metal Gasket Seal Fitting	Valve	High Temp/EP	SC-11	600°F 315°C	1000 PSI	
96-1051	Swagelok® 1/4" Female Nut	Female Nut	Standard	SC-10	---	---	
96-1057	Swagelok® Stainless 1/4" VCR Silver Plated Gasket Retainer Assembly, 2 pcs	Gasket Assembly	Silver plated	N/A	---	---	

STANDARD ASSEMBLY COMPONENTS

Assembly components are not available for individual sale.



Swagelok® Cylinder, 50ml



Swagelok® 1/4" Female Nut



Swagelok® 1/4" Stainless 1/4" VCR Silver Plated Gasket Retainer Assembly

Visit www.strem.com for new product information and a searchable catalog.

Strem Chemicals, Inc.
7 Mulliken Way
Newburyport, MA 01950
U.S.A
Tel: 978.499.1600
Fax: 978.465.3104
Email: info@strem.com

Strem Chemicals, Inc.
15, rue de l'Atome
Zone Industrielle
67800 BISCHHEIM France
Tel: (33) 03 88 62 52 60
Fax: (33) 03 88 62 26 81
Email: info.europe@strem.com

Strem Chemicals, Inc.
Postfach 1215
77672 KEHL
Germany
Tel: 0 78 51/ 7 58 79
Email: info.europe@strem.com

Strem Chemicals UK Ltd.
An Independent Distributor of Strem Chemicals Products
Newton Hall, Town Street
Newton, Cambridge
England CB22 7ZE
Tel: 0845 643 7263
Fax: 0845 643 7362
Email: enquiries@strem.co.uk

ELECTROPOLISHED (EP) ASSEMBLY WITH BALL VALVE

96-1075 Swagelok® Cylinder Assembly, 50ml with 1/4" VCR Male Ball Valve (SC-11 cleaned) and Female Nut, electropolished for CVD/ALD

1/4" VCR Male Ball Valve (EP) rated to 300°F or 148°C



Catalog #	Item Description	Category	Type	Cleaning	Temperature Rating	Pressure Rating	
96-1054	Swagelok® Cylinder, Electropolished, 50ml	Cylinder Body	EP	SC-11	---	---	 <p>96-1059 Valve</p>
96-1059	Swagelok® 1/4" Male Ball Valve, VCR Metal Gasket Face Seal Fitting, SC-11 cleaned	Valve	EP	SC-11	300°F 148°C	2500 PSI	
96-1056	Swagelok® 1/4" Female Nut, SC-11 cleaned	Female Nut	EP	SC-11	---	---	
96-1058	Swagelok® Stainless 1/4" VCR Unplated Gasket Retainer Assembly, 2 pcs	Gasket Assembly	Unplated	N/A	---	---	

ELECTROPOLISHED (EP) ASSEMBLY WITH HIGH-TEMP VALVE

96-1076 Swagelok® Cylinder Assembly, 50ml with 1/4" VCR Male Bellows-Sealed Valve (High Temp) and Female Nut, electropolished for CVD/ALD

1/4" VCR Male Bellows-Sealed Valve (High Temp/EP) rated to 600°F or 315°C



Catalog #	Item Description	Category	Type	Cleaning	Temperature Rating	Pressure Rating	
96-1054	Swagelok® Cylinder, Electropolished, 50ml	Cylinder Body	EP	SC-11	---	---	 <p>96-1053 Valve</p>
96-1053	Swagelok® 1/4" Male Bellows-Sealed Valve (High-Temp) VCR Metal Gasket Seal Fitting, SC-11 cleaned	Valve	High Temp/ EP	SC-11	600°F 315°C	1000 PSI	
96-1056	Swagelok® 1/4" Female Nut, SC-11 cleaned	Female Nut	EP	SC-11	---	---	
96-1058	Swagelok® Stainless 1/4" VCR Unplated Gasket Retainer Assembly, 2 pcs	Gasket Assembly	Unplated	N/A	---	---	

ELECTROPOLISHED ASSEMBLY COMPONENTS

Assembly components are not available for individual sale.



Swagelok® Cylinder, Electropolished, 50ml



Swagelok® 1/4" Female Nut, SC-11 cleaned



Swagelok® 1/4" Stainless 1/4" VCR Unplated Gasket Retainer Assembly

Visit www.strem.com for new product information and a searchable catalog.

Strem Chemicals, Inc.
7 Mulliken Way
Newburyport, MA 01950
U.S.A
Tel: 978.499.1600
Fax: 978.465.3104
Email: info@strem.com

Strem Chemicals, Inc.
15, rue de l'Atome
Zone Industrielle
67800 BISCHHEIM France
Tel: (33) 03 88 62 52 60
Fax: (33) 03 88 62 26 81
Email: info.europe@strem.com

Strem Chemicals, Inc.
Postfach 1215
77672 KEHL
Germany
Tel: 0 78 51/ 7 58 79
Email: info.europe@strem.com

Strem Chemicals UK Ltd.
An Independent Distributor of Strem Chemicals Products
Newton Hall, Town Street
Newton, Cambridge
England CB22 7ZE
Tel: 0845 643 7263
Fax: 0845 643 7362
Email: enquiries@strem.co.uk

DP VALVE ASSEMBLY - ULTRA HIGH PURITY

96-1077 Swagelok® Cylinder Assembly, 50ml with 1/4" VCR Male DP Valve (Ultra High Purity) and Female Nut, electropolished for CVD/ALD

1/4" VCR Male DP high pressure diaphragm Valve (Ultra High Purity/EP) rated to 50-320°F or 10-148°C

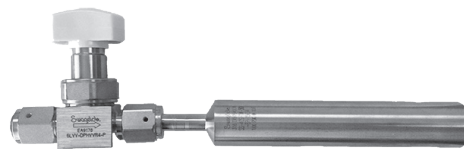

Catalog #	Item Description	Category	Type	Cleaning	Temperature Rating	Pressure Rating	
96-1054	Swagelok® Cylinder, Electropolished 50ml	Cylinder Body	EP	SC-11	---	---	 96-1055 Valve
96-1055	Swagelok® 1/4" Male DP high pressure diaphragm Valve (Ultra High Purity), polyimide seat, VCR Metal Gasket Seal Fitting, SC-01 cleaned	Valve	Ultra High Purity/EP	SC-01	50° - 302°F 10° - 148°C	3045 PSI	
96-1056	Swagelok® 1/4" Female Nut, SC-11 cleaned	Female Nut	EP	SC-11	---	---	
96-1058	Swagelok® Stainless 1/4" VCR Unplated Gasket Retainer Assembly, 2 pcs	Gasket Assembly	Unplated	N/A	---	---	

DP HIGH PRESSURE VALVE ASSEMBLY - HIGH PURITY

96-1078 Swagelok® Cylinder Assembly, 50ml with 1/4" VCR Male DP High Pressure Valve (High Purity), PCTFE seat, VCR Metal Gasket Seal Fitting, Round Handle

1/4" VCR Male DP high pressure diaphragm Valve (High Purity/EP) rated to 250°F or 121°C



Catalog #	Item Description	Category	Type	Cleaning	Temperature Rating	Pressure Rating	
96-1054	Swagelok® Cylinder, Electropolished, 50ml	Cylinder Body	EP	SC-11	---	---	 96-1060 Valve
96-1060	Swagelok® 1/4" Male DP high pressure diaphragm Valve (High Purity), PCTFE seat, VCR Metal Gasket Seal Fitting, Round handle, SC-11 cleaned	Valve	High Purity/EP	SC-11	250°F 121°C	2800 PSI	
96-1056	Swagelok® 1/4" Female Nut, SC-11 cleaned	Female Nut	EP	SC-11	---	---	
96-1058	Swagelok® Stainless 1/4" VCR Unplated Gasket Retainer Assembly, 2 pcs	Gasket Assembly	Unplated	N/A	---	---	

DP VALVE ASSEMBLY COMPONENTS

Assembly components are not available for individual sale.



Swagelok® Cylinder, Electropolished, 50ml



Swagelok® 1/4" Female Nut, SC-11 cleaned



Swagelok® 1/4" Stainless 1/4" VCR Unplated Gasket Retainer Assembly

Visit www.strem.com for new product information and a searchable catalog.

Strem Chemicals, Inc.
 7 Mulliken Way
 Newburyport, MA 01950
 U.S.A
 Tel: 978.499.1600
 Fax: 978.465.3104
 Email: info@strem.com

Strem Chemicals, Inc.
 15, rue de l'Atome
 Zone Industrielle
 67800 BISCHHEIM France
 Tel: (33) 03 88 62 52 60
 Fax: (33) 03 88 62 26 81
 Email: info.europe@strem.com

Strem Chemicals, Inc.
 Postfach 1215
 77672 KEHL
 Germany
 Tel: 0 78 51/ 7 58 79
 Email: info.europe@strem.com

Strem Chemicals UK Ltd.
 An Independent Distributor of Strem Chemicals Products
 Newton Hall, Town Street
 Newton, Cambridge
 England CB22 7ZE
 Tel: 0845 643 7263
 Fax: 0845 643 7362
 Email: enquiries@strem.co.uk

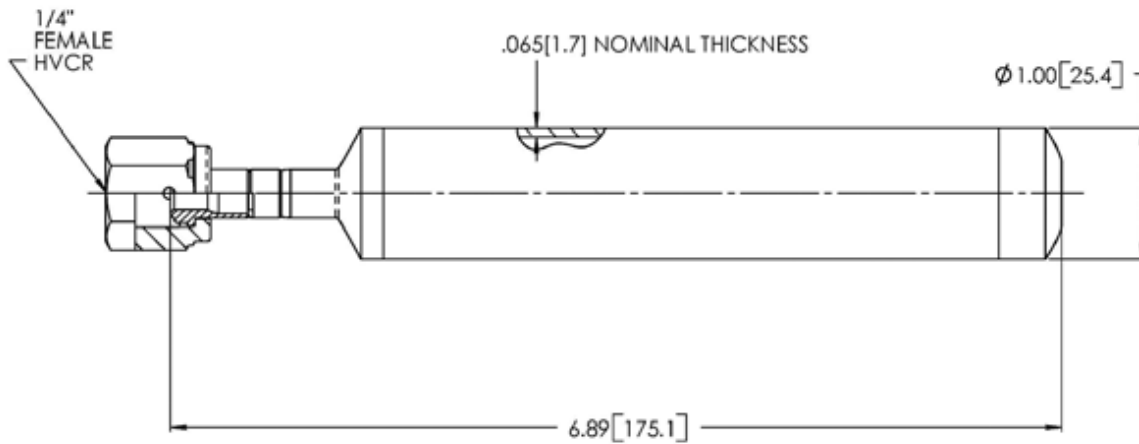

- Drawing is not to scale
- Dimensions are in inches [millimeters in brackets]
- Drawing subject to change without notice

Definition of Swagelok® Cleaning Codes

SC-01	Ultra High Purity Process - DI water cleaning system is closed to the environment and limits contamination. A series of ultrasonic washing and multistage DI water rinse before drying.
SC-10	Standard Cleaning - Basic industrial procedures.
SC-11	Special Cleaning - Multistep process that ensures thorough cleaning, rinsing, draining and drying.

Swagelok® Trademark is owned by Swagelok Company. Registered user in Canada: SWAGELOK Canada, Ltd. SWAGELOK AG is an authorized user in Switzerland of the SWAGELOK trademark.

ADDITIONAL CYLINDERS FOR ALD

95-4154 Stainless steel cylinder, 200ml, single vertical stem, electropolished with fill-port, PCTFE valve stem tip, DOT 4B, UN stamped

Cylinder Size	2" Diameter
Cylinder Working Volume	200ml
Cylinder Total Volume	233ml
Cylinder Tare Weight	2.75 lbs
Design Pressure	300PSI
Test Pressure	600PSI
Design Temperature	250°F/121°C
Fillport	1/2" MCVR
Outlet Valve	SS-DSTW4
D.O.T. Specification	4B-300

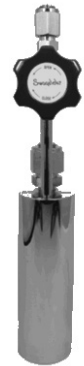
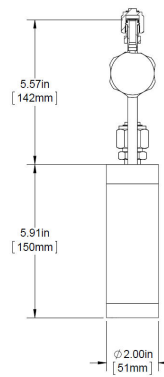

95-0281 Stainless steel cylinder, 125ml, horizontal in line, with angled Bellows valve (150°C), DOT 4B, UN stamped

Cylinder Size	2.5" Diameter
Cylinder Working Volume	125ml
Cylinder Total Volume	137ml
Cylinder Tare Weight	1.89 lbs
Design Pressure	260PSI
Test Pressure	520PSI
Design Temperature	-10 to 150 C*
Inlet Valve	FUJIKIN, FUB-81-6.35-PI
D.O.T. Specification	4B-260

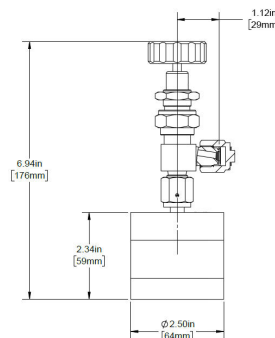

* The FUB-81-6.35-PI valve is rated for 150°C but per the manufacturer, it can be heated to 175°C if the total number of cycles does not exceed 200 annually during usage

Visit www.strem.com for new product information and a searchable catalog.

Strem Chemicals, Inc.
7 Mulliken Way
Newburyport, MA 01950
U.S.A
Tel: 978.499.1600
Fax: 978.465.3104
Email: info@strem.com

Strem Chemicals, Inc.
15, rue de l'Atome
Zone Industrielle
67800 BISCHHEIM France
Tel: (33) 03 88 62 52 60
Fax: (33) 03 88 62 26 81
Email: info.europe@strem.com

Strem Chemicals, Inc.
Postfach 1215
77672 KEHL
Germany
Tel: 0 78 51/ 7 58 79
Email: info.europe@strem.com

Strem Chemicals UK Ltd.
An Independent Distributor of Strem Chemicals Products
Newton Hall, Town Street
Newton, Cambridge
England CB22 7ZE
Tel: 0845 643 7263
Fax: 0845 643 7362
Email: enquiries@strem.co.uk