

## STANDARD ASSEMBLY

**96-1070 Swagelok® Cylinder Assembly, 50ml with 1/4" VCR Male Ball Valve and Female Nut for CVD/ALD**

1/4" VCR Male Ball Valve rated to 300°F or 148°C



Catalog #	Item Description	Category	Type	Cleaning	Temperature Rating	Pressure Rating	
96-1050	Swagelok® Cylinder, 50ml	Cylinder Body	Standard	SC-11	---	---	<p>96-1052 Valve</p>
96-1052	Swagelok® 1/4" Male Ball Valve, VCR Metal Gasket Face Seal Fitting	Valve	Standard	SC-10	300°F 148°C	2500 PSI	
96-1051	Swagelok® 1/4" Female Nut	Female Nut	Standard	SC-10	---	---	
96-1057	Swagelok® Stainless 1/4" VCR Silver Plated Gasket Retainer Assembly, 2 pcs	Gasket Assembly	Silver plated	N/A	---	---	

## HIGH-TEMP VALVE ASSEMBLY

**96-1071 Swagelok® Cylinder Assembly, 50ml with 1/4" VCR Male Bellows-Sealed Valve (High Temp) and Female Nut for CVD/ALD**

1/4" VCR Male Bellows-Sealed Valve (High Temp/EP) rated to 600°F or 315°C

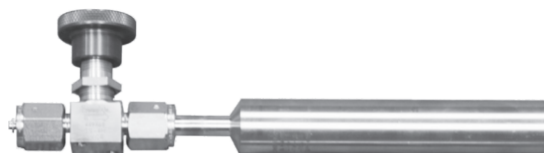

Catalog #	Item Description	Category	Type	Cleaning	Temperature Rating	Pressure Rating	
96-1050	Swagelok® Cylinder, 50ml	Cylinder Body	Standard	SC-11	---	---	<p>96-1053 Valve</p>
96-1053	Swagelok® 1/4" Male Bellows-Sealed Valve (High-Temp) VCR Metal Gasket Seal Fitting	Valve	High Temp/EP	SC-11	600°F 315°C	1000 PSI	
96-1051	Swagelok® 1/4" Female Nut	Female Nut	Standard	SC-10	---	---	
96-1057	Swagelok® Stainless 1/4" VCR Silver Plated Gasket Retainer Assembly, 2 pcs	Gasket Assembly	Silver plated	N/A	---	---	

## STANDARD ASSEMBLY COMPONENTS

*Assembly components are not available for individual sale.*



Swagelok® Cylinder, 50ml



Swagelok® 1/4" Female Nut



Swagelok® 1/4" Stainless 1/4" VCR Silver Plated Gasket Retainer Assembly

Visit [www.strem.com](http://www.strem.com) for new product information and a searchable catalog.

**Strem Chemicals, Inc.**  
7 Mulliken Way  
Newburyport, MA 01950  
U.S.A  
Tel: 978.499.1600  
Fax: 978.465.3104  
Email: [info@strem.com](mailto:info@strem.com)

**Strem Chemicals, Inc.**  
15, rue de l'Atome  
Zone Industrielle  
67800 BISCHHEIM France  
Tel: (33) 03 88 62 52 60  
Fax: (33) 03 88 62 26 81  
Email: [info.europe@strem.com](mailto:info.europe@strem.com)

**Strem Chemicals, Inc.**  
Postfach 1215  
77672 KEHL  
Germany  
Tel: 0 78 51/ 7 58 79  
Email: [info.europe@strem.com](mailto:info.europe@strem.com)

**Strem Chemicals UK Ltd.**  
An Independent Distributor of Strem Chemicals Products  
Newton Hall, Town Street  
Newton, Cambridge  
England CB22 7ZE  
Tel: 0845 643 7263  
Fax: 0845 643 7362  
Email: [enquiries@strem.co.uk](mailto:enquiries@strem.co.uk)

## ELECTROPOLISHED (EP) ASSEMBLY WITH BALL VALVE

**96-1075 Swagelok® Cylinder Assembly, 50ml with 1/4" VCR Male Ball Valve (SC-11 cleaned) and Female Nut, electropolished for CVD/ALD**

1/4" VCR Male Ball Valve (EP) rated to 300°F or 148°C



Catalog #	Item Description	Category	Type	Cleaning	Temperature Rating	Pressure Rating	
96-1054	Swagelok® Cylinder, Electropolished, 50ml	Cylinder Body	EP	SC-11	---	---	 <p>96-1059 Valve</p>
96-1059	Swagelok® 1/4" Male Ball Valve, VCR Metal Gasket Face Seal Fitting, SC-11 cleaned	Valve	EP	SC-11	300°F 148°C	2500 PSI	
96-1056	Swagelok® 1/4" Female Nut, SC-11 cleaned	Female Nut	EP	SC-11	---	---	
96-1058	Swagelok® Stainless 1/4" VCR Unplated Gasket Retainer Assembly, 2 pcs	Gasket Assembly	Unplated	N/A	---	---	

## ELECTROPOLISHED (EP) ASSEMBLY WITH HIGH-TEMP VALVE

**96-1076 Swagelok® Cylinder Assembly, 50ml with 1/4" VCR Male Bellows-Sealed Valve (High Temp) and Female Nut, electropolished for CVD/ALD**

1/4" VCR Male Bellows-Sealed Valve (High Temp/EP) rated to 600°F or 315°C



Catalog #	Item Description	Category	Type	Cleaning	Temperature Rating	Pressure Rating	
96-1054	Swagelok® Cylinder, Electropolished, 50ml	Cylinder Body	EP	SC-11	---	---	 <p>96-1053 Valve</p>
96-1053	Swagelok® 1/4" Male Bellows-Sealed Valve (High-Temp) VCR Metal Gasket Seal Fitting, SC-11 cleaned	Valve	High Temp/ EP	SC-11	600°F 315°C	1000 PSI	
96-1056	Swagelok® 1/4" Female Nut, SC-11 cleaned	Female Nut	EP	SC-11	---	---	
96-1058	Swagelok® Stainless 1/4" VCR Unplated Gasket Retainer Assembly, 2 pcs	Gasket Assembly	Unplated	N/A	---	---	

## ELECTROPOLISHED ASSEMBLY COMPONENTS

*Assembly components are not available for individual sale.*



Swagelok® Cylinder, Electropolished, 50ml



Swagelok® 1/4" Female Nut, SC-11 cleaned



Swagelok® 1/4" Stainless 1/4" VCR Unplated Gasket Retainer Assembly

Visit [www.strem.com](http://www.strem.com) for new product information and a searchable catalog.

**Strem Chemicals, Inc.**  
7 Mulliken Way  
Newburyport, MA 01950  
U.S.A  
Tel: 978.499.1600  
Fax: 978.465.3104  
Email: [info@strem.com](mailto:info@strem.com)

**Strem Chemicals, Inc.**  
15, rue de l'Atome  
Zone Industrielle  
67800 BISCHHEIM France  
Tel: (33) 03 88 62 52 60  
Fax: (33) 03 88 62 26 81  
Email: [info.europe@strem.com](mailto:info.europe@strem.com)

**Strem Chemicals, Inc.**  
Postfach 1215  
77672 KEHL  
Germany  
Tel: 0 78 51/ 7 58 79  
Email: [info.europe@strem.com](mailto:info.europe@strem.com)

**Strem Chemicals UK Ltd.**  
An Independent Distributor of Strem Chemicals Products  
Newton Hall, Town Street  
Newton, Cambridge  
England CB22 7ZE  
Tel: 0845 643 7263  
Fax: 0845 643 7362  
Email: [enquiries@strem.co.uk](mailto:enquiries@strem.co.uk)

## DP VALVE ASSEMBLY - ULTRA HIGH PURITY

**96-1077 Swagelok® Cylinder Assembly, 50ml with 1/4" VCR Male DP Valve (Ultra High Purity) and Female Nut, electropolished for CVD/ALD**

1/4" VCR Male DP high pressure diaphragm Valve (Ultra High Purity/EP) rated to 50-320°F or 10-148°C

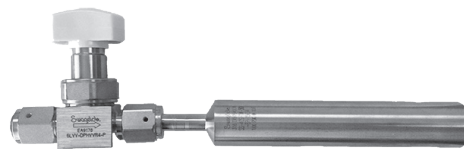

Catalog #	Item Description	Category	Type	Cleaning	Temperature Rating	Pressure Rating	
96-1054	Swagelok® Cylinder, Electropolished 50ml	Cylinder Body	EP	SC-11	---	---	 96-1055 Valve
96-1055	Swagelok® 1/4" Male DP high pressure diaphragm Valve (Ultra High Purity), polyimide seat, VCR Metal Gasket Seal Fitting, SC-01 cleaned	Valve	Ultra High Purity/EP	SC-01	50° - 302°F 10° - 148°C	3045 PSI	
96-1056	Swagelok® 1/4" Female Nut, SC-11 cleaned	Female Nut	EP	SC-11	---	---	
96-1058	Swagelok® Stainless 1/4" VCR Unplated Gasket Retainer Assembly, 2 pcs	Gasket Assembly	Unplated	N/A	---	---	

## DP HIGH PRESSURE VALVE ASSEMBLY - HIGH PURITY

**96-1078 Swagelok® Cylinder Assembly, 50ml with 1/4" VCR Male DP High Pressure Valve (High Purity), PCTFE seat, VCR Metal Gasket Seal Fitting, Round Handle**

1/4" VCR Male DP high pressure diaphragm Valve (High Purity/EP) rated to 250°F or 121°C



Catalog #	Item Description	Category	Type	Cleaning	Temperature Rating	Pressure Rating	
96-1054	Swagelok® Cylinder, Electropolished, 50ml	Cylinder Body	EP	SC-11	---	---	 96-1060 Valve
96-1060	Swagelok® 1/4" Male DP high pressure diaphragm Valve (High Purity), PCTFE seat, VCR Metal Gasket Seal Fitting, Round handle, SC-11 cleaned	Valve	High Purity/EP	SC-11	250°F 121°C	2800 PSI	
96-1056	Swagelok® 1/4" Female Nut, SC-11 cleaned	Female Nut	EP	SC-11	---	---	
96-1058	Swagelok® Stainless 1/4" VCR Unplated Gasket Retainer Assembly, 2 pcs	Gasket Assembly	Unplated	N/A	---	---	

## DP VALVE ASSEMBLY COMPONENTS

*Assembly components are not available for individual sale.*



Swagelok® Cylinder, Electropolished, 50ml



Swagelok® 1/4" Female Nut, SC-11 cleaned



Swagelok® 1/4" Stainless 1/4" VCR Unplated Gasket Retainer Assembly

Visit [www.strem.com](http://www.strem.com) for new product information and a searchable catalog.

**Strem Chemicals, Inc.**  
 7 Mulliken Way  
 Newburyport, MA 01950  
 U.S.A  
 Tel: 978.499.1600  
 Fax: 978.465.3104  
 Email: info@strem.com

**Strem Chemicals, Inc.**  
 15, rue de l'Atome  
 Zone Industrielle  
 67800 BISCHHEIM France  
 Tel: (33) 03 88 62 52 60  
 Fax: (33) 03 88 62 26 81  
 Email: info.europe@strem.com

**Strem Chemicals, Inc.**  
 Postfach 1215  
 77672 KEHL  
 Germany  
 Tel: 0 78 51/ 7 58 79  
 Email: info.europe@strem.com

**Strem Chemicals UK Ltd.**  
 An Independent Distributor of Strem Chemicals Products  
 Newton Hall, Town Street  
 Newton, Cambridge  
 England CB22 7ZE  
 Tel: 0845 643 7263  
 Fax: 0845 643 7362  
 Email: enquiries@strem.co.uk

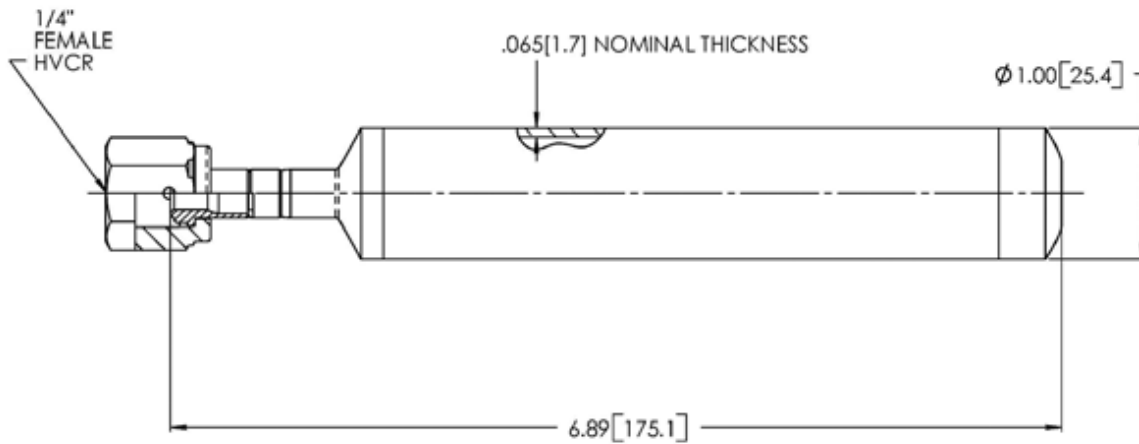

- Drawing is not to scale
- Dimensions are in inches [millimeters in brackets]
- Drawing subject to change without notice

### Definition of Swagelok® Cleaning Codes

<b>SC-01</b>	Ultra High Purity Process - DI water cleaning system is closed to the environment and limits contamination. A series of ultrasonic washing and multistage DI water rinse before drying.
<b>SC-10</b>	Standard Cleaning - Basic industrial procedures.
<b>SC-11</b>	Special Cleaning - Multistep process that ensures thorough cleaning, rinsing, draining and drying.

Swagelok® Trademark is owned by Swagelok Company. Registered user in Canada: SWAGELOK Canada, Ltd. SWAGELOK AG is an authorized user in Switzerland of the SWAGELOK trademark.

### ADDITIONAL CYLINDERS FOR ALD

**95-4154** Stainless steel cylinder, 200ml, single vertical stem, electropolished with fill-port, PCTFE valve stem tip, DOT 4B, UN stamped

Cylinder Size	2" Diameter
Cylinder Working Volume	200ml
Cylinder Total Volume	233ml
Cylinder Tare Weight	2.75 lbs
Design Pressure	300PSI
Test Pressure	600PSI
Design Temperature	250°F/121°C
Fillport	1/2" MCVR
Outlet Valve	SS-DSTW4
D.O.T. Specification	4B-300

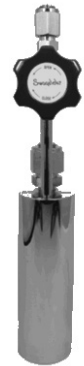
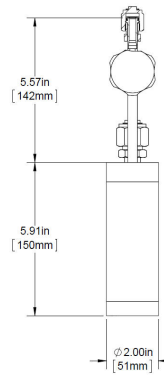

**95-0281** Stainless steel cylinder, 125ml, horizontal in line, with angled Bellows valve (150°C), DOT 4B, UN stamped

Cylinder Size	2.5" Diameter
Cylinder Working Volume	125ml
Cylinder Total Volume	137ml
Cylinder Tare Weight	1.89 lbs
Design Pressure	260PSI
Test Pressure	520PSI
Design Temperature	-10 to 150 C*
Inlet Valve	FUJIKIN, FUB-81-6.35-PI
D.O.T. Specification	4B-260

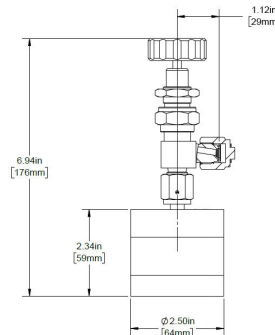

\* The FUB-81-6.35-PI valve is rated for 150°C but per the manufacturer, it can be heated to 175°C if the total number of cycles does not exceed 200 annually during usage

Visit [www.strem.com](http://www.strem.com) for new product information and a searchable catalog.

**Strem Chemicals, Inc.**  
7 Mulliken Way  
Newburyport, MA 01950  
U.S.A  
Tel: 978.499.1600  
Fax: 978.465.3104  
Email: info@strem.com

**Strem Chemicals, Inc.**  
15, rue de l'Atome  
Zone Industrielle  
67800 BISCHHEIM France  
Tel: (33) 03 88 62 52 60  
Fax: (33) 03 88 62 26 81  
Email: info.europe@strem.com

**Strem Chemicals, Inc.**  
Postfach 1215  
77672 KEHL  
Germany  
Tel: 0 78 51/ 7 58 79  
Email: info.europe@strem.com

**Strem Chemicals UK Ltd.**  
An Independent Distributor of Strem Chemicals Products  
Newton Hall, Town Street  
Newton, Cambridge  
England CB22 7ZE  
Tel: 0845 643 7263  
Fax: 0845 643 7362  
Email: enquiries@strem.co.uk